

# AP363636M

ITEM	PART NO.	WT.
ASSEMBLY	AP363636M	555 LBS
PALLET QTY	2	1185 LBS
LID	CM3636B	113 X 2 LBS
ENCLOSURE	BP363636B	329 LBS

**PART DESCRIPTION:**

36" x 36" x 36"  
 POLYMER CONCRETE ASSEMBLY  
 STRAIGHT WALL, OPEN BOTTOM

**LOAD RATING:**

- TIER 15
- TIER 22

**BOLT DOWN:**

- HEX HEAD (STANDARD)
- PENTA HEAD

**LOGO OPTIONS:**

- ELECTRIC
  - COMMUNICATIONS
  - FIBER OPTICS
  - BLANK
  - WATER
  - LIGHTING
  - STREET LIGHTING
  - CAVITY (LOGO SOLD SEPARATELY)
- \*OTHER OPTIONS AVAILABLE (CONTACT FACTORY)

**AVAILABLE OPTIONS:**

- EMS MARKER, POWER
  - EMS MARKER, TELEPHONE
  - MOUSEHOLES
  - CABLE RACKING (LOC. & QTY. REQ'D.)
  - PULLING EYES
- \*OTHER OPTIONS AVAILABLE (CONTACT FACTORY)

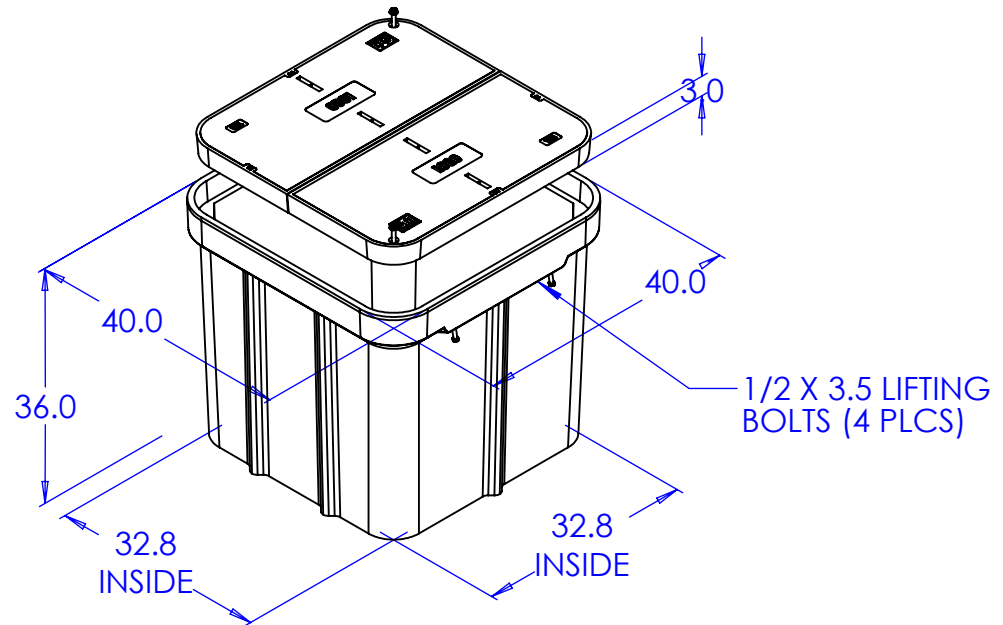
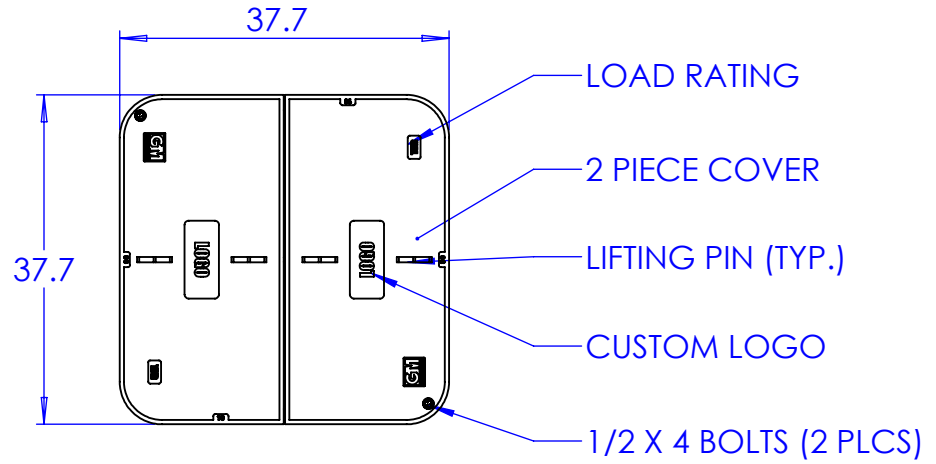

GLASMASTERS, INC.  
 8873 WESTERN WAY, JAX., FL 32256  
 (904) 400-7100 - (904) 358-1702 FAX  
 WWW.GLASMASTERS.COM