

Atlas Wall Pak Pro

American Lighting

Project Information

Job Name

Fixture Type 13 Watt LED Die Cast Wall Pak

Catalog Number WPS13LED

Approved by

WPS13LED 13 Watt LED Wall Pak



3000K or warmer CCTs only

SPECIFICATIONS:

	WPS13LED3K	WPS13LED4K	WPS13LED	WPS13LED5K
Lumens:	1629	1629	1629	1682
Watts:	13.91	13.91	13.91	13.92
Lumens/Watt:	120.74	120.74	120.74	124.60
CRI:	80	80	80	80
CCT:	3000	4000	4500	5000
DLC Prod. ID:	PVJH7CJE	P6AGAL13	PH2CR05Y	PL67HA93

Construction:

Designed for commercial and industrial applications, providing cooler operating temperatures, brighter light and longer LED life. Manufactured w/ 100% pure aluminum and 0% remelt. Apertures for field or factory installed photocontrol.

Installation:

Labor saving quick mount box with apertures for continuous wiring.

Zero Glare:

Using the latest high brightness, high LED count technology, more usable light output is produced while eliminating glare. The fixture design directs more light down and forward without wasting lumens and offensive light.

Thermal Management:

Atlas Wall Pak Pro fixtures are designed as a complete system to optimize LED life and light output. The Patent Pending thermal stacking heat removal technology extracts heat from within the housing moving it away from LEDs and components. The lower temperatures result in long LED life (200,000+ hrs) and component life and also allows for higher light output.

Listings:

Luminaire is certified to UL/cUL Standards for Wet Locations DesignLights Consortium Premium qualified luminaire, eligible for rebates from DLC member utilities.

AC Input:

120/208/240/277 V

Driver:

Constant current, Class 2, 120-277 VAC, 50-60 Hz
High Efficiency – min. 84%
Off-State Power: 0 Watts
0-10 V Dimming

LEDs:

3000K, 4000K, 4500K, 5000K CCT
Epoxy Guard™ protective conformal coated boards

Testing:

Atlas LED luminaires have been tested by an independent laboratory in accordance with IESNA LM-79 & LM-80.

Warranty: Five-year limited warranty

Photo Control:

For factory installed 120V button photo control add suffix PC to part number.



WPS13LED Design is Protected by US Patents D710,530 and D752,274



DIMENSIONS:

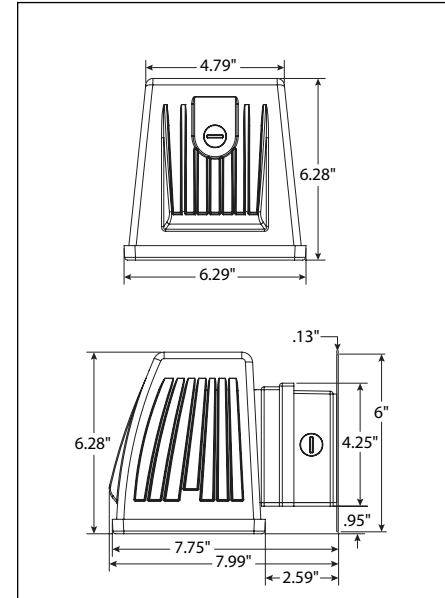

¹LED Life Span Based Upon LM-80 Test Results

ATLAS LIGHTING PRODUCTS, INC.

PO BOX 2348 | BURLINGTON, NC 27216
800-849-8485 | FAX: 1-855-847-2794 | www.atlasled.com

Rebates and Incentives are available in many areas. Contact an Atlas Representative for more information.

*The majority of Atlas Lighting Products are assembled in USA facilities by an American Workforce utilizing both Domestic and Foreign components. Meets Buy American requirements within the ARRA.

ORDERING FORMAT

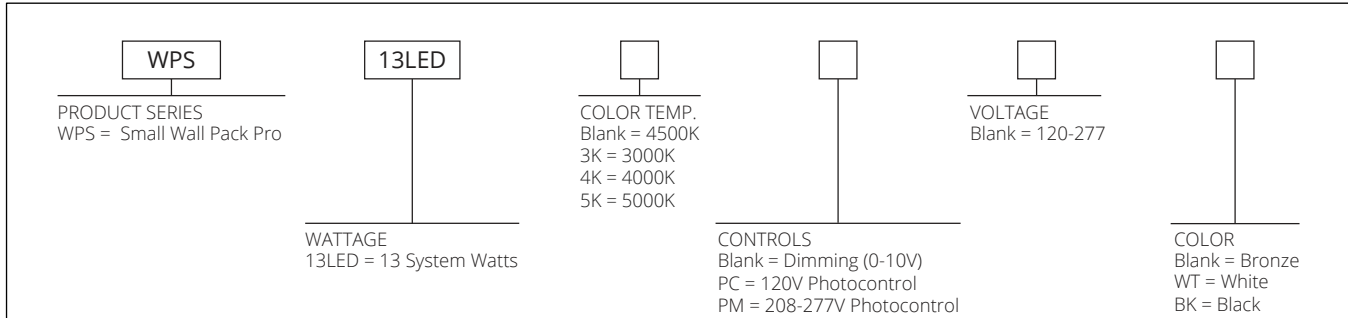

LABOR SAVING: QUICK & SECURE MOUNTING

Protected by US Patent D752,274

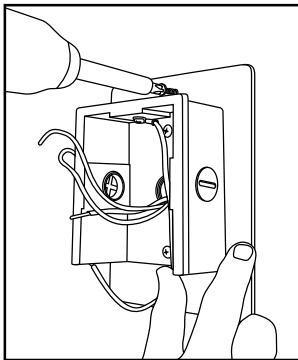

Secure Mounting Plate with back box to wall

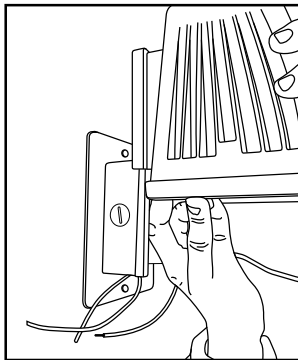

Slide fixture housing onto mounting box

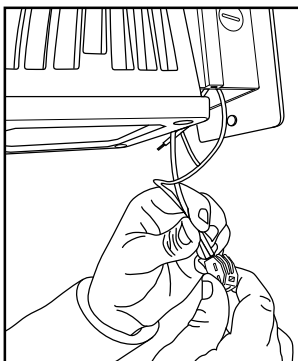

Connect wires & return them to mounting box

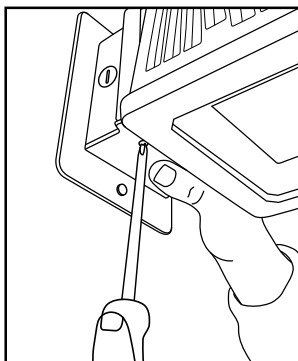

Replace bottom plate on quick mount box

PHOTOMETRIC

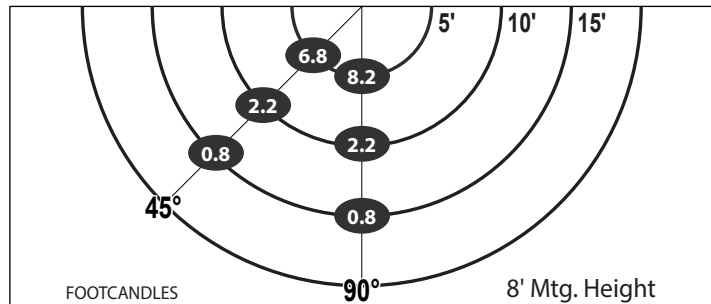

ENERGY SAVINGS

LED		HID			ANNUAL SAVINGS
WATTAGE	ANNUAL COST	SOURCE WATTAGE	TOTAL WATTAGE USED	ANNUAL COST	
13	\$6	50	72	\$52	\$46
13	\$6	70	90	\$59	\$53